

Elix[®] Essential 3, 5, 10, 15 Water Purification Systems

Consistently pure, reliable water quality for optimal results

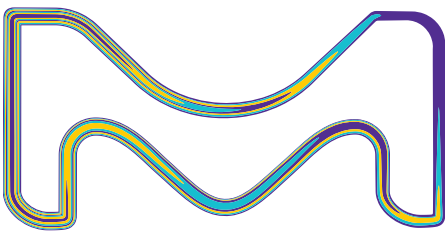

The life science business
of Merck operates as
MilliporeSigma in the
U.S. and Canada.

Milli-Q[®]
Lab Water Solutions

Consistently pure, reliable water quality for optimal results

For pure water needs up to 15 L/h

Your water purification needs	Our solution: The Elix® Essential range of water purification systems
Type 2 pure water of consistent and reliable quality	Complementary water purification techniques, including state-of-the-art Elix® electrodeionization (EDI) technology , ensure delivery of constant and reliable quality Type 2 pure water.
High-quality pure water meeting the specifications for your applications	With resistivity > 5 MΩ·cm at 25° (typically 10–15 MΩ·cm) and TOC < 30 ppb, Elix® Essential system product water is of better quality than double distilled water .
Low and predictable running costs	With no resin packs to change, the self-regenerating Elix® EDI module lowers running costs . Overall reduced water and electricity use also allow significant savings.
A user-friendly system	Intuitive controls simplify Elix® Essential system use, providing just the information required . System alert and alarm icons are shown on a color-coded backlit LCD display to clearly show message importance.
Full control of pure water quality	Key water quality parameters are measured by the system's high-precision monitoring equipment . RFID technology makes Progard® pretreatment packs fully traceable.
Easy maintenance	On the system, there is just one Progard® pretreatment pack to change and a new, ergonomic pack locking system lets users do this quickly and easily. Automatic functions provide additional self-maintenance.
The best use of laboratory space	Elix® Essential systems have a small footprint , enabling convenient installation on or under the bench, or on a wall. Systems provide 3, 5, 10, or 15 liters of pure water per hour.
Confidence in your water purification system supplier	Elix® Essential systems are manufactured in an ISO®-registered manufacturing site , and Milli-Q® Service Plans offer a full range of support . We are a partner you can count on.

Elix® Essential Systems Water Purification Pathway

- | | | |
|---------------------------------|--------------------------------|--------------------------------|
| 1. Feed Water | 8. RO Membrane | 15. Permeate Divert Valve |
| 2. Inlet Solenoid Valve | 9. Reject Water Recovery Loop | 16. Elix® EDI Module |
| 3. Progard® Pretreatment Pack | 10. Check Valve | 17. Product Resistivity Cell |
| 4. Pressure Regulator | 11. Capillary Tubing | 18. UV Lamp 254 nm (UV System) |
| 5. Pump | 12. Flush Solenoid Valve | 19. Product Water |
| 6. Sanitization Port | 13. Reject | 20. Reservoir |
| 7. Feed Water Conductivity Cell | 14. Permeate Conductivity Cell | |

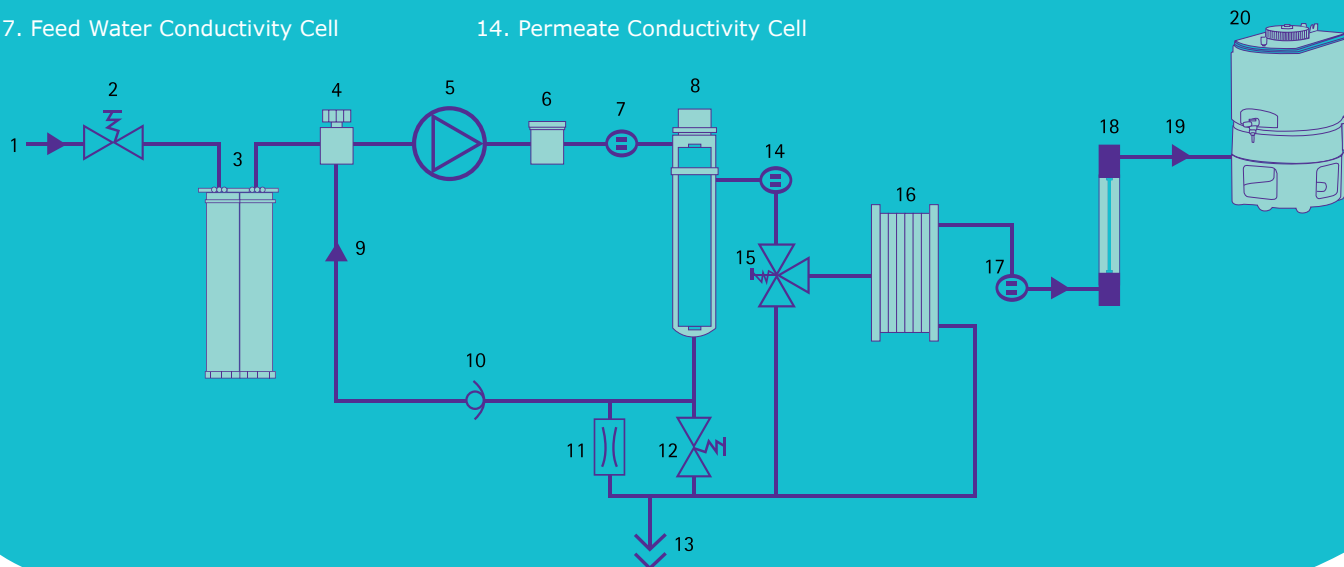

Elix® technology: Constant and reliable quality Type 2 pure water

Type 2 pure water is one of the most common reagents. It is used by scientists, researchers, and engineers everywhere in environments as diverse as academic, hospital, and quality control laboratories. In spite of its importance, many water purification systems on the market are not able to reliably provide pure water of consistent quality in the daily volumes required by users.

In contrast to these other systems, our Elix® Essential systems have been developed to ensure delivery of constant and reliable quality Type 2 water. By incorporating proven, patented Elix® EDI technology with other advanced complementary water purification techniques, Elix® Essential systems make the best use of existing purification technologies.

Elix® Essential system water purification sequence

In the Elix® Essential system water purification sequence, potable tap water is first treated with a Progard® pack, and then purified by reverse osmosis (RO) to produce RO Type 3 water. This water enters the Elix® electrodeionization module, where ion-exchange resins are continuously regenerated by a small electrical field. This process requires only very small amounts of water and energy, and results in consistently high-quality pure water with no need for external chemical regeneration of the resin beads. In Elix® UV systems, a bactericidal 254 nm UV lamp is available to sanitize the pure water before it is stored in a polyethylene reservoir.

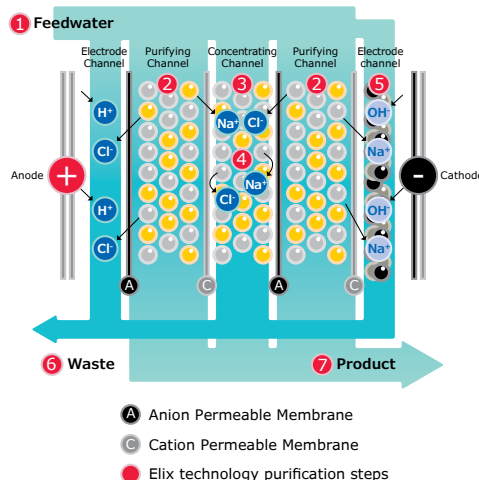

Elix® module: unique technology based on anion- and cation permeable membranes; high-quality ion-exchange resin; and activated carbon beads.

Elix® Technology

Our current Elix® EDI module is the result of over 25 years of concentrated activity by our Lab Water Research & Development teams. Today, our extensive worldwide installed base of Elix® systems provides the assurance that Elix® EDI technology is robust, reliable and efficient: you can trust Elix® Essential systems to supply the solution to your pure water needs.

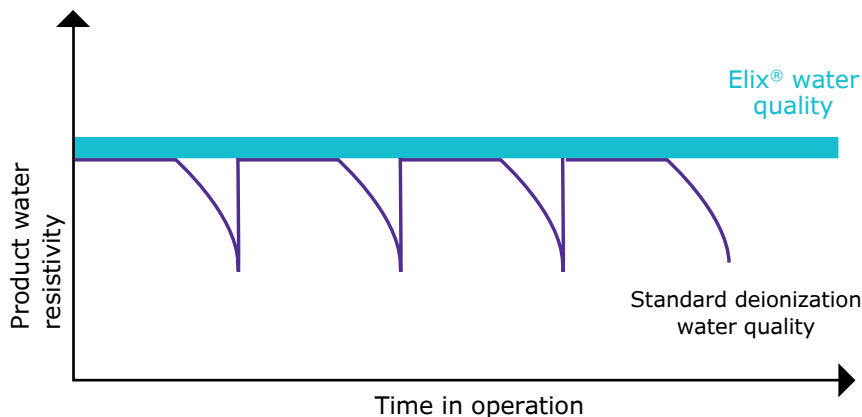

The graph shows the superiority of Elix® technology over systems using ion-exchange resin packs. Resistivity drops dramatically when packs are exhausted.

High-quality pure water to match your specifications

Consistency and reliability in pure water quality is crucial in laboratory applications. Pure water, such as the water produced by Elix® Essential systems, is used throughout the lab for:

- Feed to laboratory equipment (e.g., Milli-Q® Type 1 ultrapure water systems, weatherometers, autoclaves, glassware washers, and dissolution testing units)
- Preparation of microbiological media, buffer and pH solutions
- Histology
- Chemical reactions run in water
- Manual glassware rinsing

Regulatory bodies have defined the minimum quality requirements for pure water through specific and rigorous standards. Elix® Essential systems are designed to meet or exceed requirements as described by ISO® 3696 (Grade 2 water); ASTM® D1193 (Type II resistivity and TOC Table I specifications); and by the United States, European and Japanese Pharmacopeias for Purified Water.

With resistivity values that are greater than 5 MΩ·cm at 25 °C, and with less than 30 ppb TOC, the quality of Elix® Essential water exceeds that of double distilled water. In general, water that has been purified using Elix® technology is suitable for use with analyses at the parts per million (ppm) or high parts per billion (ppb) levels.



Low and predictable running costs

Budget-conscious users will also appreciate Elix® Essential systems for their low and predictable running costs:

- Integrated Elix® electrodeionization technology requires no costly resin replacement or regeneration.
- Only a single Progard® pretreatment pack is needed to remove particles, free chlorine and colloids from tap water.
- Electricity consumption is 200 times less than that of conventional distillation equipment.
- The system's efficient RO-reject water recirculation loop significantly reduces tap water use and helps extend the lifetime of the Progard® pack.
- No strong chemicals must be purchased for resin regeneration or cleaning purposes.
- There are no transportation and storage costs (as with bulky and cumbersome resin cartridges or bottled water).



User-friendly systems

Elix® Essential systems have been designed for easy, effortless operation. Intuitive controls on the system cabinet simplify use, and provide essential details — you see just the information you need, such as product water quality and reservoir water level. When necessary, icons inform users of any actions that should be performed (i.e., changing the Progard® pack, sanitizing the system, or taking corrective measures in case of an alert or alarm).

To ensure optimal system operation, icons and the backlit LCD screen change color to visually signal maintenance alerts or alarms. For example, fifteen days before the purification pack should be replaced, the Progard® icon will turn yellow. As the date for pack change approaches, the LCD screen will switch from its normal blue background color to yellow. For more important warnings, the screen will turn red to indicate an urgent action is required. When there has been no user interaction with the screen for 15 minutes, and there is no alert or alarm, the system's screen saver will be activated automatically.

Additional information on system operation and maintenance is provided by the Quick Reference Guide and User Manual stored on the water production unit.



Full control over pure water quality



In comparison to centralized water delivery installations with a “loop” configuration, stand-alone, reliable Elix® Essential systems give users direct “hands-on” control over water quality. After each purification step, important parameters are checked by the system, including:

- Feed water pressure and conductivity
- RO pressure, RO water quality, RO membrane efficiency (% ion rejection), Elix® Essential water quality and temperature

Elix® Essential system monitoring equipment is best in class. Reliable resistivity measurement provides control with features such as low cell constant, flow-through resistivity cell design, and temperature compensation at 25 °C.

Key values can be displayed on the easy-to-read Elix® Essential system LCD display, letting users check water quality status whenever needed. Any system anomaly is immediately signaled by a change in the color of the highly visible LCD backlight (yellow for alert mode; red for alarm mode).

On another level, RFID technology prevents insertion of an incorrect purification cartridge in the Elix® Essential system, and also ensures traceability by registering the catalogue and serial numbers of a new Progard® pack in system memory.

For enhanced data management control, remote access capabilities, and long-term electronic archiving, users can also opt to use their Elix® Essential systems with Millitrack® software.

Easy and carefree maintenance

Low maintenance Elix® Essential systems free you to concentrate on your laboratory work. Elix® technology eliminates the need for extra polishing packs or conditioning cartridges, so there is just one Progard® purification pack to change — and the system’s new ergonomic pack locking system makes this easier than ever to do.

Just pull up on the locking handle to remove the exhausted pack, position the replacement pack in the cabinet, and push down on the handle to lock the new pack in place — it’s as simple as that! This is followed by an automatic 15-minute flush cycle, and your system is once again ready for use.

Automatic self-maintenance functions (i.e., flush mode, rinsing mode, sanitization cycle) keep the system’s RO membrane in top operating condition, and ensure optimal water quality. System sanitization is recommended approximately four times a year, and takes just a few minutes to perform.



The best use of laboratory space

With their small footprint, Elix® Essential systems are designed to make the best use of laboratory space. Systems can be placed on or under the bench or wall-installed, depending on your needs. Systems provide 3, 5, 10, or 15 liters of pure water per hour.

Select from a range of high-quality polyethylene reservoirs (30–100 liters) to match your water usage. Reservoirs maintain consistent purity of stored water and provide effective protection against airborne contaminants. An optional Automatic Sanitation Module (ASM) can further protect the integrity of stored water with regular exposure to a bactericidal 254 nm UV lamp.



Confidence in your water purification system supplier

As one of the top three R&D investors in the Life Science Tools industry and with more than 50 years of experience in water purification systems manufacturing, we are a partner you can count on.

Elix® Essential systems are manufactured in an ISO® 9001 and ISO 14001 registered site,* and are certified for safety and electromagnetic compatibility (CE, cUL, FCC).

Additionally, to optimize the performance and lifetime of your water purification system, we offer a complete portfolio of Milli-Q® Service Plans ranging from a single annual checkup to full system coverage.

* Certificates are available upon request.

Elix® Essential System Specifications

Pure (Type 2) Product Water Quality	Elix® Essential Systems
Product flow rate ±15%, 7–35 °C	3, 5, 10, or 15 L/h
Resistivity	> 5 MΩ·cm at 25 °C, typically 10–15 MΩ·cm
TOC	< 30 ppb
Bacteria levels	< 10 cfu/mL for Elix® Essential UV systems

System Information

Dimensions (H × W × D)	470 × 268 × 339 mm (18.5 × 10.6 × 13.3 in.)
Net weight	12.3–14 kg (27.1–30.9 lb)
Operating weight	17.2–18.5 kg (37.9–40.8 lb)
Electrical feed voltage	100–230 V ± 10%
Electrical feed frequency	50–60 Hz
Tap (feed) water connection	1/2" Gaz M
Tap (feed) water pressure	0.5–6 bar

Milli-Q®

Lab Water Solutions

© 2018 Merck KGaA, Darmstadt, Germany and/or its affiliates. All Rights Reserved. Merck, Milli-Q, the Vibrant M, Elix, Progard, Milli-Q and Millitrack are trademarks of Merck KGaA, Darmstadt, Germany or its affiliates. All other trademarks are the property of their respective owners. Detailed information on trademarks is available via publicly accessible resources.

Lit. No. PB1777EN00 Version 2.0
2017 - 01351
05/2018

Storage Tanks and Accessories

Storage with a Difference



Guarantee the purity of your stored water

Pure water requires a storage system to prevent the degradation of your water quality. Merck Millipore's 30-, 60-, and 100-liter polyethylene (PE) storage tanks are designed to maintain consistent purity of stored water and provide effective protection against airborne contaminants.*

Prevent contamination

Water stagnancy can cause bacterial proliferation. Our optimal Automatic Sanitization Module (ASM) provides the ideal solution for the prevention of bacterial growth and biofilm formation on the inner surface of the storage tank. In addition, our advanced vent filter protects pure water from airborne contamination.

Distribute your stored water where it is needed

To provide pure water for use with all of their applications, laboratories need to be able to distribute stored water from their water purification system storage tanks.

- For distribution of **non-pressurized pure water**, a valve is conveniently located on the front of the Merck Millipore storage tanks.
- For convenient **distribution of pressurized pure water** from the storage tank, an E-POD® point-of-delivery dispenser can be connected to an Elix® Advantage or Milli-Q® Integral water purification system.
- For **automatic feed** of pure water, distribution valves on the base of the storage tank allow connection to other laboratory equipment such as glassware washing machines. Distribution pumps are also available if needed.

** A complete line of storage tanks is available, ranging in capacity from a few liters to several hundred liters. Your nearest Merck Millipore office will be able to guide you in the choice of the tank best suited to your needs.*

Optimized pure water storage

The main concern when storing pure water is degradation of water purity over time. Only a strict choice of storage tank materials, associated with a careful design and appropriate protection against airborne contaminants, can ensure consistent water quality during storage.

Innovative storage tank design

Merck Millipore 30-, 60-, and 100-liter polyethylene storage tanks incorporate the latest technical developments and advanced features for stored water of consistent purity.

All tanks have a small footprint and are designed for wall-mounting if required. Underbench installation is also possible for some models.

Unique features

- Polyethylene selected for its minimum release of extractables
- Opaque walls block sunlight to prevent algae development
- Smooth inner surface prevents biofilm formation
- Cylindrical shape minimizes surface area in contact with water
- Conical bottom allows complete draining for cleaning and rinsing
- Pure water smoothly fed in at the bottom of the tank prevents absorption of carbon dioxide
- Front valve enables manual dispense of pure water
- Distribution valves permit connection to other laboratory equipment
- Hermetically sealed lid blocks air from entering the tank
- Large top opening allows manual cleaning during sanitization procedure
- Compact space-saving design

Fail-safe protection

- Sensor rod float switch system for automatic storage tank refill and indication of water level (% full)
- Overflow connected to the drain, in the unlikely event of a water system malfunction
- Direct display of stored water level on water purification system units
- Water sensor

Storage tanks designed for efficiency

Designed for efficiency

1. Hermetically sealed lid
2. Sensor rod float switch
3. Sanitary overflow
4. Blow-molded storage tank
5. Cylindrical shape
6. Conical bottom with distribution valves
7. Front dispensing valve
8. Advanced vent filter

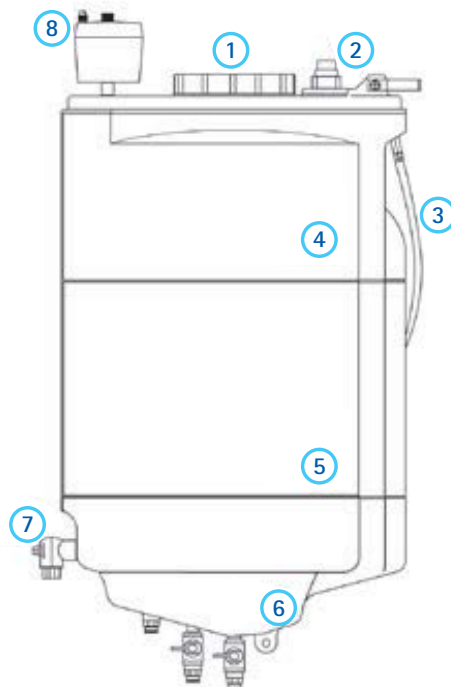

For details of the tests performed during the storage tank development process, please request the publication "R&D Notebook 1: Optimizing the storage of purified water for laboratory applications" (Ref. No.: RDO01EN00) from your local Merck Millipore representative.

Storage Tank Accessories

In order to help ensure optimum purity and distribution of your stored water, Merck Millipore offers a range of accessories and connections for your storage tank, including the following items:

- Advanced Vent Filter
- Automatic Sanitization Module
- Air Gap Device
- E-POD® pure water remote dispenser
- Washer Distribution Kit
- Water Sensor
- Lab Close Kit

Advanced vent filter: important protection against airborne contaminants

Air is contaminated by carbon dioxide, particles, microorganisms, and volatile organic compounds that come mainly from the laboratory atmosphere. To protect pure water from all these contaminants, Merck Millipore has developed an advanced storage tank vent filter that includes:

- Activated carbon to adsorb volatile organics (including lab solvents such as acetone, chloroform, and methanol)
- A soda-lime bed to remove CO₂
- A Durapore® hydrophobic membrane for particle and bacteria retention

This advanced vent filter is recommended for the protection of high-resistivity water, such as Elix® product water, during storage. To protect RiOs™ reverse osmosis-quality water, a Durapore® 0.45 µm hydrophobic membrane vent filter is also available.

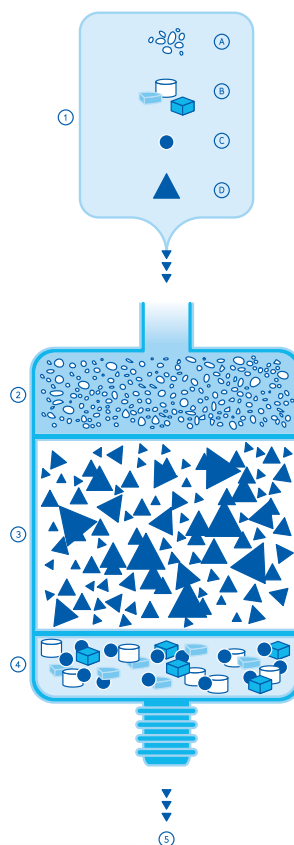

Advanced storage tank vent filter

1. Airborne Contaminants
 - A. Volatile Organics
 - B. Particles
 - C. Bacteria
 - D. CO₂
2. Volatile Organics absorption
3. CO₂ removal
4. Particle and Bacterial retention
5. Storage tank inlet
Purified air enters the storage tank



Complete Merck Millipore water purification chain with the ASM and water sensor

Automatic Sanitization Module (ASM):
say "No!" to bacterial proliferation

Maintaining high purity water with low bacteria levels during storage is critical. If left to proliferate, trace levels of microorganisms present in pure water compromise water purity. This bacterial contamination is responsible for the formation of a biofilm – an accumulation of organic material made up of active and dead organisms, on the inner walls of the storage tank.

Even though chemical sanitization and mechanical scrubbing may be periodically performed, this biofilm is difficult to remove and is a frequent source of recontamination in stored water.

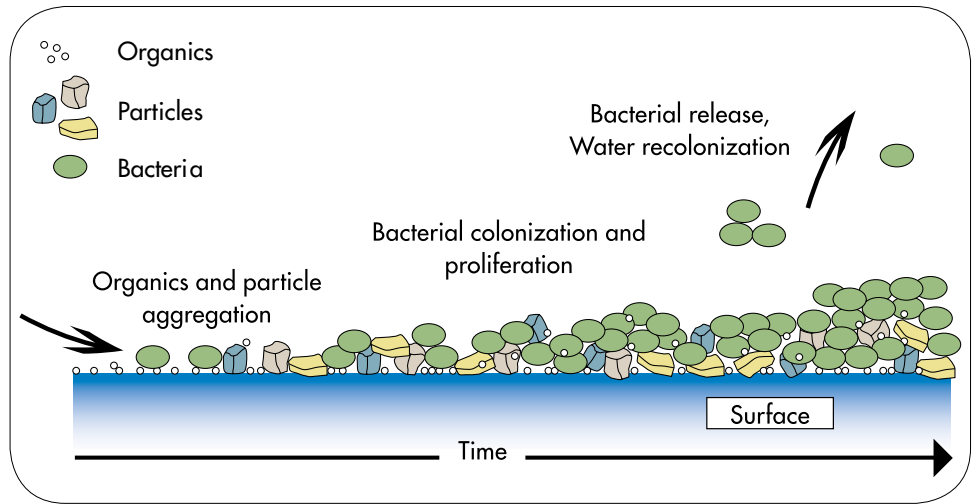

Biofilm formation over time

Merck Millipore's ASM is designed to prevent the growth and proliferation of bacteria and the resulting biofilm on the inner surface of Merck Millipore PE storage tanks. The ASM makes use of the germicidal properties of an ultraviolet (UV) light at 254 nm, which is fitted inside the tank.

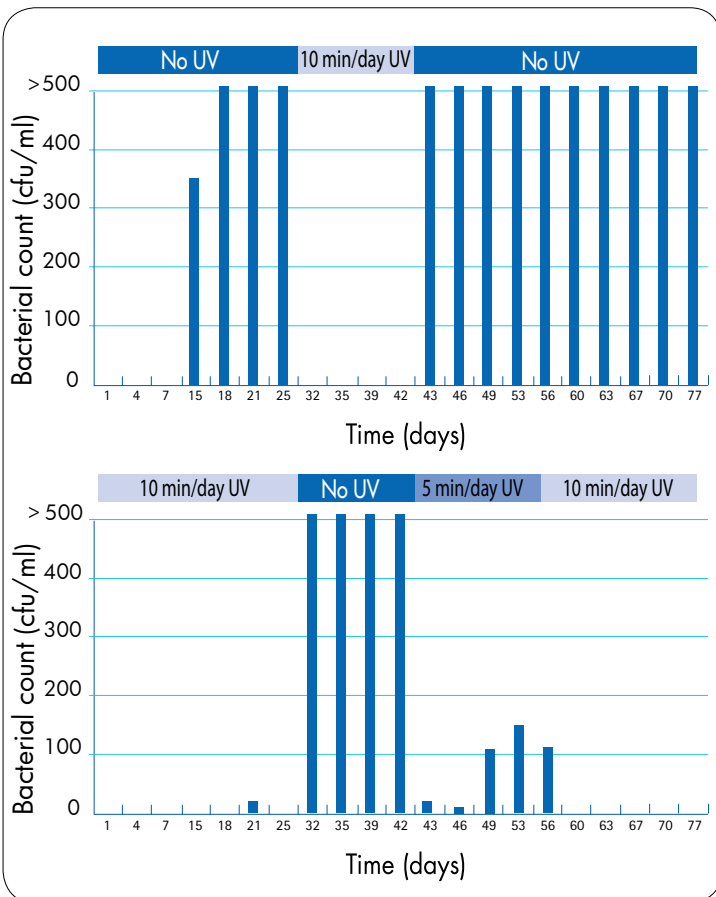

Germicidal effectiveness of the UV lamp

The ASM provides full flexibility for guaranteed results

- 254 nm UV lamp; selected for its germicidal effectiveness
- Pre-programmed intervals of 10-min / day automatic UV illumination for optimized efficiency
- Additional programmable and manual UV exposure possible to meet critical application requirements
- Up to 45 min /day of UV exposure for total flexibility
- Program daily time settings, UV cycles, and UV lamp operation displayed on the Millitrack® e-Solution dashboard
- UV lamp exchange alarm for easy maintenance
- Compact design allowing installation on top of the storage tank

10 minutes of daily UV exposure is sufficient

During development of the ASM, the UV lamp exposure cycles were optimized by examining the resulting bacterial reduction after exposure.

Two 60-liter storage tanks were fed by an intentionally contaminated reverse osmosis water purification system. The tanks were then emptied and refilled each day and alternately equipped with an ASM into which variable illumination times were programmed.

As shown in the graphs, 10 minutes per day of UV exposure were enough to make the tanks return to their original low bacterial levels.

Air gap device for protection against bacteriological contamination

Water purification systems and storage tanks sometimes require a connection to the drain.

Drains are typically dirty environments contaminated by microorganisms, and in particular, bacteria. Therefore, when the outlet of the water system reject tubing is pushed into the drain, there is a risk that bacteria could contaminate the inside of the reject tubing, and then progressively move to the water system.

One way to prevent this from occurring is to install an air gap device on the reject tubing. This allows the reject water flow to move through the tubing without touching the inside of the contaminated drain environment. Installing an air gap device is an easy and safe way to prevent the development of bacteria above the air gap level.



Air Gap Device

E-POD® pure water remote dispenser: pure water where you need it

The E-POD® Elix® water point-of-delivery unit can be connected to an Elix® Advantage pure water system or Milli-Q® Integral pure and ultrapure water system to dispense pure water wherever it is needed in the lab.

Advantages of the E-POD® remote dispenser include:

- Improved bacterial water quality (less than 0.1 cfu/mL, with final filter)
- Versatility enabling use for multiple applications or users when a Millipak® or Biopak® polisher is fitted to the dispenser outlet

- Volumetric dispensing to save time
- Ergonomic design and ease of use
- Flexibility, with installation of up to three E-POD® units per system
- Information at a glance thanks to the color backlit screen on the dispenser base
- Space-saving small footprint



E-POD® pure water remote dispenser



Distribution pumps to meet increased demands

Washer Distribution Kit

A key use of pure water is as feed to laboratory appliances such as glassware washers, autoclaves, sterilizers and weathering devices.

The Merck Millipore Washer Distribution Kit provides cost-effective and convenient distribution of pure water to common laboratory appliances, with flow rates between 12.5 – 13.5 L/min (at 2 bar or 30 psi, depending on voltage).

Installation of the small-footprint kit is fast, easy, and universal, with bench, underbench, or wall-mounted options. Users profit from a silent, automatic supply of pure water when required.

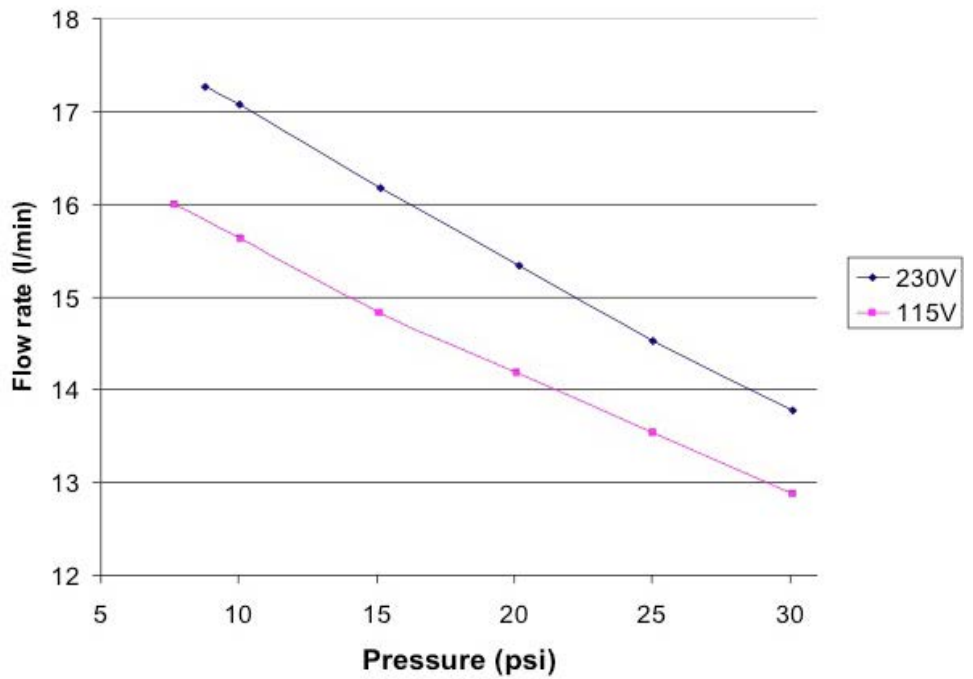

The graph shows characteristics of Merck Millipore distribution pumps. Pumps provide a long service lifetime and quiet operation.



Washer Distribution Kit

Water sensor for control over feed water supply

If there is water on the floor, the water sensor enables shutdown of the feed water supply in order to prevent a lab flood.

Lab Close Kit keeps your system in top condition when you're away

When your facility is closed for an extended time – such as vacation periods – the Lab Close Kit will avoid water purification system standstill during these long periods. The Lab Close Kit intelligently optimizes the consumption of water and electricity by your system, preventing the negative effects of nonuse, such as bacteria buildup. Your water purification system remains in top condition, ready for immediate use upon your return.

Specifications & Ordering Information

Specifications for Polyethylene Storage Tanks

There are several different storage tank sizes available in this range:

30-liter Storage Tank*

Diameter	380 mm (14.82 in.)
Height	600 mm (23.4 in.)
Maximum Usable Capacity	25 L
Weight (full)	30 kg (66.14 lb)

60-liter Storage Tank

Diameter	380 mm (14.82 in.)
Height	840 mm (32.76 in.)
Maximum Usable Capacity	54 L
Weight (full)	59 kg (130.07 lb)

100-liter Storage Tank*

Diameter	380 mm (14.82 in.)
Height	1255 mm (48.95 in.)
Maximum Usable Capacity	91 L
Weight (full)	98.5 kg (217.15 lb)

* For 30-liter and 100-liter storage tanks, underbench models are also available.

Ordering Information

Description	Catalogue No.
Polyethylene Storage Tanks	
30-liter PE tank	TANKPE030
30-liter PE underbench tank	TANKBI030
60-liter PE tank	TANKPE060
100-liter PE tank	TANKPE100
100-liter PE underbench tank	ZBITANK01

Description	Catalogue No.
-------------	---------------

Accessories

Advanced Vent Filter

Advanced vent filter (for Elix® water purification systems)	TANKMPK01
Standard vent filter (for RiOs™ water purification systems)	TANKMPK02

Automatic Sanitization Module

Milli-Q® Integral; Milli-Q® Direct, Elix® Advantage, and Elix® Reference water purification systems	TANKASMIN
ASM for RiOs™ / Elix® / AFS® Essential water purification systems	TANKASMES

Air Gap Device

Air Gap Device	AIRGAP001
----------------	-----------

E-POD® Pure Water Remote Dispenser

E-POD® pure water dispenser	ZRXSP0D01
-----------------------------	-----------

Washer Distribution Kit

Washer Distribution Kit (Left) 230 V	ZWDK5L100
Washer Distribution Kit (Left) 115 V	ZWDK6L100
Washer Distribution Kit (Right) 230 V	ZWDK5R100
Washer Distribution Kit (Right) 115 V	ZWDK6R100

Water Sensor

Connection from the system	ZFWATDET4
Connection from the tap water source	ZFWATDET1 (120 V) or ZFWATDET2 (230 V)
Water sensor with cable	TANKLK002

Lab Close Kit

Milli-Q® Integral; Elix® Advantage; Elix® Reference; and Milli-Q® Direct water purification systems	LABCLOSE1
RiOs™ / Elix® / AFS® Essential water purification systems	Included, setting to be activated



WolfLabs

Pricing on any accessories shown can be found by keying the part number into the search box on our website.

The specifications listed in this brochure are subject to change by the manufacturer and therefore cannot be guaranteed to be correct. If there are aspects of the specification that must be guaranteed, please provide these to our sales team so that details can be confirmed.

www.wolflabs.co.uk

Tel : 01759 301142

Fax : 01759 301143

sales@wolflabs.co.uk

Please contact us if this literature doesn't answer all your questions.